

# CAL 9900 AUTOTUNE PID TEMPERATURE CONTROLLER INSTALLATION AND OPERATING MANUAL

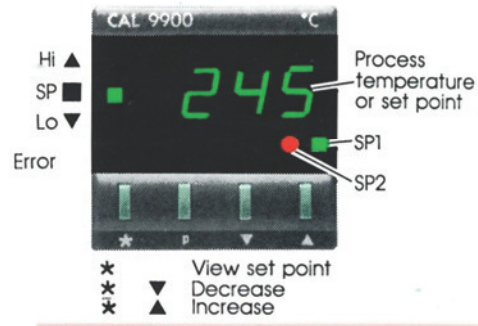
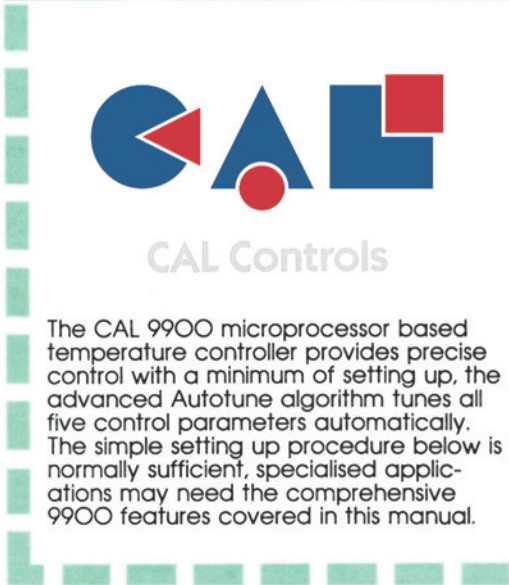

**KEY CONTENTS GUIDE**  
 9 Important caution - please read first  
 10 Installation 1 Setting up  
 2, 3, 5 Autotune 6 Prop cycle-time  
 Functions: 4 Selection 8 Table  
 7 Alarms 11 Error messages

## INSTALLATION

Install the 9900 controller in panel **see 10.2**  
 Wire up connections **see 10.1**

### 1 TO SELECT SENSOR AND ADJUST SET POINT

**Step 1**  
 POWER UP  
 Self check sequence

**Step 2**  
 ZERO FLASHES ON LEFT  
 Indicating no sensor selected

**Note**  
 Buttons only adjust flashing digits  
**(shown green)**

**Step 3**  
 PRESS **▲** TO SELECT SENSOR e.g. Type K = 2  
 Sensor options:  
**(For full table see 8)**

J	1	R	4	E	7	RTD	9
K	2	S	5	L	8	PT100	
N	3	T	6	B	10		

**Step 4**  
 PRESS **P** TO ENTER SENSOR INTO MEMORY  
 Display shows process temperature e.g. Ambient

**Step 5**  
 PRESS **\*** TO DISPLAY SET POINT

**Step 6**  
 PRESS AND HOLD **\***  
 TO INCREASE SET POINT  
 PRESS **▲**

Output turns on and temperature rises

The controller is now operational with factory PID settings:

Prop band 2.5%
Prop time 20 sec
Derivative 25 sec
Integral 5 min
DAC approach control 1.5

**Step 8**  
 PRESS **P** TO ACCESS PROGRAM MODE  
 Function O flashes on right

**Step 9**  
 PRESS **\*** TO CHANGE TO OPTION SELECTION  
 Option O flashes on left

**Step 10**  
 PRESS **▲** TO SELECT AUTOTUNE 'AT'  
 Option 1

**Step 11**  
 PRESS **P** TO START AUTOTUNE 'AT'

AT and Process temperature displayed alternately during Autotune

Autotuned parameters	Autotune limits
Entered automatically: Proportional band/Gain	0.5 - 2C <sub>o</sub> c/range
Integral time/Reset	0.2 - 43.5 min
Derivative time/Rate	1.0 - 255 sec
DAC approach control	0.5 - 9.0 x gain

Proportional cycle time 0.8 - 819 sec  
 Calculated but for safety reasons needs manual acceptance **see 6**

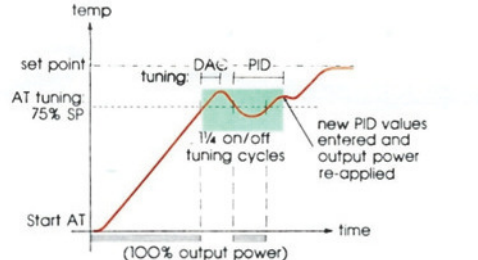

Fig. 1 Autotune AT

**3.2 AUTOTUNE PT (Push-to-Tune)**  
 Select Opt 2 at step 10  
 Used to fine tune difficult applications at set point. Useful if the set point or thermal conditions are substantially changed. During PT tuning some overshoot will occur. If this is unacceptable, temporarily reduce set point. PT tunes the parameters listed above except DAC. Proportional cycle time is re-calculated but needs manual acceptance

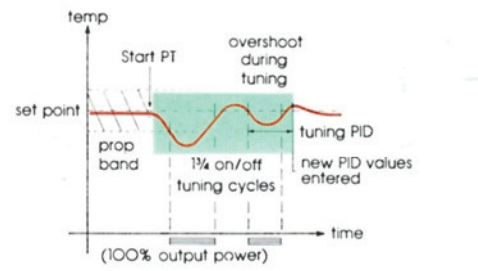

Fig. 2 Autotune PT

### 2 IMPORTANT - Please read before using Autotune AT

- 1 If required adjust: Range, Hi-res 0.1°, Negative temperature ranging. **see 8**
- 2 Proportional cycle-time: 20 sec factory set, if unsuitable change now or use Autotune calculated value after tuning run **see 6**
- 3 For best results use normal set point and load conditions
- 4 Start Autotune AT with the load cool

### TO AUTOTUNE

**Step 7**  
 START AUTOTUNE 'AT'  
 NEAR AMBIENT

### 3 AUTOTUNE TYPES AND USES

Two types of Autotune are provided to ensure optimum control of a wide range of applications

AUTOTUNE AT - Normal method, tunes during warm up

AUTOTUNE PT - (Push-to-Tune) - For difficult applications, tunes at set point

#### 3.1 AUTOTUNE AT

Start Autotune AT with the load cool. A short tuning cycle occurs at 75% set point during warm up. New PID values are automatically entered and the temperature rises to set point

**3.3 OVERRIDING AUTOTUNE VALUES**  
 After AT/PT any Autotuned parameter will be changed to an Option from the table. The original Autotuned value is retained in memory.  
 Note Subsequent Autotune AT or PT run replaces manual selections with new calculated values (except Cycle time)



#### 4 CONTROLLER FUNCTIONS DISPLAY AND SELECTION PROCEDURE

The facilities of the 9900 are selected from the Functions and Options Table **see 8** using program mode  
 Functions (Fn) – The available controller facilities  
 Options (Opt) – The available values for each Function e.g. Function 5 Option O (Fn 5/Opt O) = SP1 Prop band of 2.5%  
 Note 1 Should difficulty occur in adjusting Options check the Parameter lock **see 14**  
 Note 2 Normal control is maintained with existing settings during programming

TO

**Step 1**  
 PRESS **P** TO ENTER PROGRAM MODE

**Step 2**  
 PRESS AND HOLD **▲** INDEX TO FUNCTION e.g. Function 16 (Sensor select) flashes

**Step 3**  
 PRESS **\*** CHANGE TO OPTION SELECTION e.g. Option 2 (Type K)

**Step 4**  
 PRESS **▼** or **▲** SELECT OPTION REQUIRED e.g. Option 1 (Type J)

**Step 5**  
 PRESS **\*** CHANGE TO FUNCTION SELECTION Set other Functions as required

**Step 6**  
 PRESS **P** TO EXIT PROGRAM MODE WHEN SELECTIONS COMPLETE Process temperature displayed

Control commences with new instructions now entered in memory

#### 4.2 MODE B – FUNCTION/OPTION DISPLAY PROCEDURE

Used in Function 2 to set full scale alarms and Function 24 – Range adjustment. Mode B enables all digits to be used for Options values

**Step 1**  
 PRESS **▲** TO INDEX TO FUNCTION e.g. Function 24 (Range adjustment) flashes  
 Note 2 bars = Mode B

**Step 2**  
 PRESS **\*** TO DISPLAY OPTION VALUE e.g. Range 400° flashes

**Step 3**  
 PRESS AND HOLD **\***  
 PRESS **▲** TO INCREASE  
 PRESS **▼** TO DECREASE OPTION VALUE

#### 5 AUTOTUNE HINTS

**5.1** Autotune error messages **see 11** (EE5-7) (Latched: PRESS **▼▲** to reset). AT/PT tunes most applications satisfactorily, but if tuning fails and error messages repeatedly occur, the application has unusual characteristics requiring manual tuning **see 21**

**5.2** Tuning with set point near ambient  
 Difficult both to control and Autotune. Use PT. If tuning fails try with Fn 5/Opt 1, otherwise increase set point or tune manually

**5.3** In High Resolution (O.1°)  
 Should error message EE6 occur during tuning, select normal resolution (Fn 18/Opt O) then Autotune and afterwards re-select Hi-res, (check range setting Fn 24)

**5.4** AUTOTUNE VALUE DISPLAY  
 At the end of an Autotune run the AT value is automatically entered and may be displayed in Functions:

5	Prop band/Gain
6	Derivative time/Rate
7	DAC approach control
8	Integral time/Reset

**Step 1**  
 PRESS **P** TO ENTER PROGRAM MODE

**Step 2**  
 PRESS **▲** TO INDEX TO FUNCTION e.g. Function 5 Prop band AT value = 3.5%

Note 3 LED's show an AT value displayed

#### 6 PROPORTIONAL CYCLE TIME

**6.1** Autotuned cycle time  
 Autotune calculates the optimum value but for safety reasons does not automatically implement it

**6.2** If the cycle time needed is known  
 Applications known to require shorter times than the 20 sec factory setting, including SSR drive (1 sec), linear outputs (0.05 sec) should select the appropriate Option in Function 4 using the procedure **see 4**. This setting will not be changed, but may be replaced with the calculated AT value if preferred after the Autotune run

**6.3** Normal procedure  
 Run Autotune AT **see 2**. When complete (alternating AT display stops) display the AT calculated cycle time and accept if suitable, this will then replace the 20 sec factory setting

**Step 1**  
 Index to Function 4 For procedure **see 4**  
 Option O: 20 sec factory setting

**Step 2**  
 PRESS **\*** TO CHANGE TO OPTION SELECTION

**Step 3**  
 PRESS **▲** TO DISPLAY CALCULATED AT VALUE e.g. 9.8 sec  
 Note Flashing bar shows calculated AT value is displayed

**Step 4**  
 IF AT VALUE SUITABLE  
 PRESS **P** TO ACCEPT AT VALUE NOW OPERATIONAL

OR IF AT VALUE UNSUITABLE  
 PRESS **▲** TO SELECT A SUITABLE OPTION FROM TABLE e.g. Option 4: 30 sec

**6.4** AT Cycle time values in Function 4  
 Two AT cycle time values are stored, to enable the current operational value to be retained, until a new value from a subsequent Autotune run is considered Example of two AT cycle time values after a subsequent Autotune run:

**Step 5**  
 Index to Function 4 Operational AT value – 9.8 sec As accepted previously (Step 4) Note 3 LED's ON

**Step 6**  
 PRESS **\*** TO CHANGE TO OPTION SELECTION

**Step 7**  
 PRESS **▲** TO DISPLAY Latest calculated AT value e.g. 7.2 sec Note Flashing bar

**Step 8**  
**Alternative actions:**  
 PRESS **P** to accept the latest calculated AT value – 7.2 sec which replaces 9.8 sec as the operational AT value  
 OR PRESS **▼** to display current operational AT value. Then PRESS **P** to retain 9.8 secs  
 OR PRESS **▲** to select Option from Table

#### 7 ALARMS

**7.1** SP2 Operating mode  
 The operating mode must be selected at Function 19 before adjusting SP2 at Function 2

**7.2** Alarm output operation  
 The alarm output is failsafe, SP2 relay is de-energised and SP2 red LED on during the alarm condition (Not with SP2 in Proportional mode)

**7.3** LBA – Loop break alarm **see Fig. 3**  
 LBA detects a control loop fault, and displays an error message (EE3). The alarm relay may be configured to act also LBA operates if the controller fails to receive the correct response to the output within a set time, technically:  
 LBA occurs when SP1 output is saturated 0% or 100% and the process temperature fails to move a minimum 50% prop band in the LBA time. SP1 output state is unaffected by LBA alarm condition

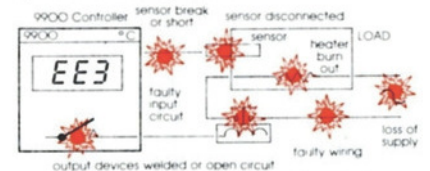

Fig. 3 Typical faults detected by LBA

**7.4** Selecting LBA – EE3 message only

- Index to Function 12 – LBA time Option O – LBA OUT, displayed
- PRESS **\*** to change to option selection
- PRESS **▼** to select Option 14 The recommended initial setting (2 x Integral time in use)
- LBA alarm condition: EE3 displayed, alternating with process temperature display latches, to reset PRESS **▼▲** together To configure Alarm relay SP2 to LBA Select Option 6 in Function 19 (Relay latches in alarm condition, to reset PRESS **▼▲**) Note Use LBA with SP2 ON/OFF mode only (Fn 10/Opt O). Reset EE3/Relay before any other program changes



**8 FUNCTIONS AND OPTIONS TABLE**  
Please read these important notes first

1. **Factory setting:** is Option O (except Functions 2 and 22)

2. **Initial configuration:** Functions 16-24 must be selected first then entered into memory by exiting Program mode - see 4 then Autotune and other Functions may be selected

3. **Protected Functions:** All Functions, except User Settings (Functions 1, 2, 3) may be locked in memory after setting to prevent tampering. See 14 Parameter lock

4. **AT values** (marked ): As calculated on the latest AT or PT run

5. **Locating Functions:** Function O is the Program mode entry point

Pressing  increments

 moves direct to Function 13 for access to higher Functions  
Hold pressed to auto index through table (Functions 13, 14, 25 are unused)

**Fn Opt No. No. Parameter**

**OPERATING MODE ... Protected**

**O Operating mode**

- O **Normal Operation**
- 1 Start Autotune AT
- 2 Start Autotune PT
- 3 Park mode
- 4 - 100 Manual heat %

**USER SETTINGS ...Unprotected**

**1 Manual Reset (OUT IN PID)**

1° steps (max ±127° / 50% prop band)

**2 SP2 Adjust**

1° steps Factory setting 5°  
SP2 mode must be selected in Function 19 before adjusting SP2

SP2 mode (Fn 19)	Option No.	Function 2 range
Deviation alarm	1 - 3	O - 127°
Full scale alarm	4 - 5	O - *
Cool strategy	7	±127°



(\* Sensor range : Fn 16)

**3 SP1 Lock**

- O Unlocked
- 1 Locked

**OPERATIONAL PARAMETERS ... Protected**

**4 SP1 Proportional cycle time**

- |            |  |
|------------|--|
| O 20 sec   | 10 3 sec   |
| 1 1 sec    | 11 7 sec   |
| 2 5 sec    | 12 14 sec  |
| 3 10 sec   | 13 45 sec  |
| 4 30 sec   | 14  <b>Operational AT value</b>       |
| 5 60 sec   | 15  <b>Latest calculated AT value</b> |
| 6 0.05 sec |  |
| 7 ON/OFF   |  |
| 8 0.3 sec  |  |
| 9 2 sec    |  |

**5 SP1 Proportional band/Gain** **SP1 Hysteresis in ON/OFF mode**

- |           |       |
|-----------|-------|
| O 2.5% CR | 1.25% |
| 1 0.5%    | 0.25% |
| 2 1%      | 0.5%  |
| 3 2%      | 1%    |
| 4 3%      | 1.5%  |
| 5 5%      | 2.5%  |
| 6 10%     | 5%    |
| 7 20%     | 10%   |
| 8 1.5%    | 0.75% |
| 9 4%      | 2%    |
| 10 6%     | 3%    |
| 11 7%     | 3.5%  |
| 12 8%     | 4%    |
| 13 14%    | 7%    |
| 14 100%   | 50%   |

15  **AT value**

**6 SP1 Derivative time/Rate**

- |           |  |
|-----------|--|
| O 25 sec  | 9 3 sec  |
| 1 OUT     | 10 7 sec   |
| 2 5 sec   | 11 15 sec  |
| 3 10 sec  | 12 20 sec  |
| 4 50 sec  | 13 35 sec  |
| 5 100 sec | 14 75 sec  |
| 6 200 sec |  |
| 7 1 sec   |  |
| 8 2 sec   | 15  <b>AT value</b> |

**Fn Opt No. No. Parameter**

**OPERATIONAL PARAMETERS ... continued**

**7 SP1 DAC approach control**

- |                   |   |
|-------------------|---|
| O 1.5 x prop band | 5 3.0   |
| 1 0.5             | 6 4.0   |
| 2 1.0             |   |
| 3 2.0             | 7  <b>AT value</b> |
| 4 2.5             |   |

**8 SP1 Integral time**

- |           |  |
|-----------|--|
| O 5 min   | 8 0.2 min  |
| 1 OUT     | 9 7 min  |
| 2 0.5 min | 10 13 min  |
| 3 1 min   | 11 25 min  |
| 4 2 min   | 12 33 min  |
| 5 3 min   | 13 43 min  |
| 6 10 min  |  |
| 7 18 min  | 14  <b>AT value</b> |

**9 Sensor error correction**

1° steps (±127° max)

**10 SP2 Proportional cycle time**

- |            |  |
|------------|--|
| O ON/OFF   | 9 3 sec                                    |
| 1 1 sec    | 10 7 sec                                   |
| 2 5 sec    | 11 14 sec                                  |
| 3 10 sec   | 12 45 sec                                  |
| 4 20 sec   | <b>Non linear ranges for Cool strategy</b> |
| 5 60 sec   | 13 0.15-10 sec                             |
| 6 0.05 sec | 14 0.15-20 sec                             |
| 7 30 sec   | 15 0.06-15 sec                             |
| 8 2 sec    |  |

**11 SP2 Proportional band/Gain** **SP2 Hysteresis in ON/OFF mode**

- |           |       |
|-----------|-------|
| O 2.5% CR | 1.25% |
| 1 0.5%    | 0.25% |
| 2 1%      | 0.5%  |
| 3 2%      | 1%    |
| 4 3%      | 1.5%  |
| 5 5%      | 2.5%  |
| 6 10%     | 5%    |
| 7 20%     | 10%   |
| 8 1.5%    | 0.75% |
| 9 4%      | 2%    |
| 10 6%     | 3%    |
| 11 7%     | 3.5%  |
| 12 8%     | 4%    |
| 13 14%    | 7%    |
| 14 100%   | 50%   |

**12 LBA ... Loop break alarm - time**

- |          |   |
|----------|---|
| O OUT    | 9 30 min                                |
| 1 1 min  | 10 40 min                               |
| 2 2 min  | 11 50 min                               |
| 3 4 min  | 12 70 min                               |
| 4 6 min  | 13 90 min                               |
| 5 8 min  | <b>Recommended initial setting:</b>     |
| 6 10 min | 14 <b>2 x Operational Integral time</b> |
| 7 15 min |   |
| 8 20 min |   |

**15 Reset Functions O - 24 to factory settings**

- O Normal
- 1 Reset (Function 22 not reset)

**Abbreviations:**

- Fn - Function
- Opt - Option
- SR - Sensor range
- CR - Configured range

**Fn Opt No. No. Parameter**

**INITIAL CONFIGURATION ... Protected**

**16 Sensor Select and Range Table**

		Range Table			
	Type	Factory set	Sensor range (SR)		
	T/C	°C	°F	°C	°F
1	J	400	800	800	1470
2	K	400	800	1200	1999
3	N	400	800	1200	1999
4	R	1600	1999	1600	1999
5	S	1600	1999	1600	1999
6	T	250	500	250	500
7	E	500	1000	600	1100
8	L	400	800	800	1470
10	B	1600	1999	1800	1999

**RTD**

9 PT100 200 400 400 750  
**Range minimum:** 0°C/32°F  
 Except T/PT100:  
 Factory set 0°C/32°F  
 Minimum available -200°C/°F

**Linear process inputs** **Display**

- |    |          |          |
|----|----------|----------|
| 11 | O - 20mV | O - 100  |
| 12 | 4 - 20mV | O - 100  |
| 13 | O - 20mV | O - 1000 |
| 14 | 4 - 20mV | O - 1000 |
| 15 | O - 20mV | O - 2000 |

**17 Negative temperature ranging**

- O Disabled
- 1 Enabled (range min -200°)

**18 Display resolution**

- O Normal (1°)
- 1 Hi-res (0.1°) ±199.9°  
 1° settings become 0.1°  
 Ranged O - 200° on selection of Hi-res. (reset with Fn 24)

**19 SP2 Operating mode**  
Select and enter Function 19 before adjusting SP2 in Function 2

- O OUT
- 1 Deviation alarm - High
- 2 Deviation alarm - Low
- 3 Deviation band alarm
- 4 Full scale alarm - High
- 5 Full scale alarm - Low
- 6 LBA - Loop break alarm
- 7 Cool strategy

**20 SP1 Sensor break**

- O Upscale
- 1 Downscale

**21 SP2 Sensor break**

- O Upscale
- 1 Downscale

**22 °C/°F (Note Change top fascia)**

- O °C } Factory set
- 1 °F } not reset by Function 15

**23 Software version number**

**24 Configured range (CR) adjustment**

- 1° steps
- Mode B adjustment see 4.2 (See Range Table in Function 16)





Designed for use: UL 873 - only in products where the acceptability is determined by Underwriters laboratories Inc.  
 EN61010-1-Within Installation Categories II and III environment and pollution degree 2.  
 To avoid possible hazards accessible conductive parts of final installation should be protectively earthed in accordance with EN61010 for Class 1 equipment.  
 Output wiring should be within a grounded cabinet. Sensor sheaths should be bonded to ground or not be accessible.  
 Live parts should not be accessible without use of a tool.

It is the responsibility of the installation engineer to ensure that this equipment's compliance to EN61010 is not impaired when fitted to the final installation and to use this equipment as specified in this manual, failure to do so may impair the protection provided. Follow wiring diagrams and regulations.

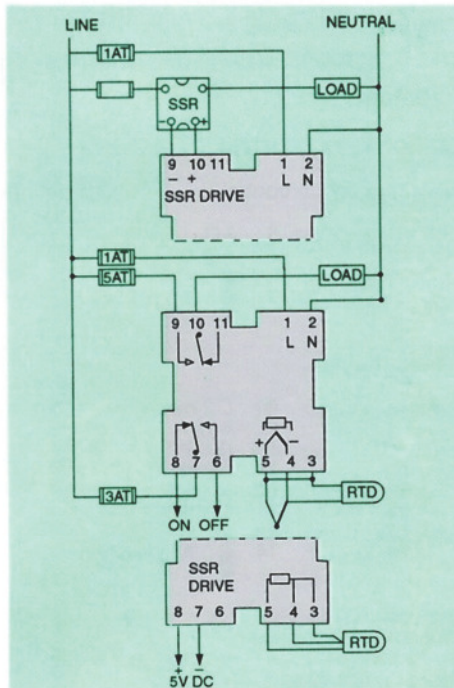

Fuses: 250VAC rated, time lag type to IEC 127.

10 INSTALLATION

10.1 ELECTRICAL INSTALLATION



CAUTION RISK OF ELECTRICAL SHOCK.

1. Check controller label is the correct supply voltage for your application.
2. Connections are shown on the socket label.
3. For connection to socket use, 250 Faston receptacles provided in accessory kit.
4. Recommended wire size for mains voltage and outputs 32/0.2 1.0mm<sup>2</sup> (18 AWG 0.04<sup>2</sup>) rated to 6 Amps/300V at 70°C.
5. For use with 2 wire RTD an external link is required between connections 3 and 5.
6. IMPORTANT. It is recommended that interference suppressors are fitted across relay contacts to prolong relay life.

12 9900 SPECIFICATION

INPUTS

See 8 Function 16 for Range Table  
**Thermocouple - 9 types**

J Iron/Constantan	T Copper/Con
K Chromel/Alumel	R Pt - 13% Rh/Pt
L Fe/Konst	S Pt - 10% Rh/Pt
N NiCroSil/NiSil	B Pt - 30% Rh
E Chromel/Con	Pt - 6% Rh

Standards: 1PTS 68/DIN 43710  
 Linearity: 5 - 95% sensor range see 8  
 J/K/L/N/E ±1°C, T ±2°C, B ±6°C >500°C  
 R/S O-300°C ±5°C, 300-1600°C ±2°C  
 CJC Rejection: 20:1 (0.05°/°C) typical  
 External resistance: 100 Ω maximum

**Resistance thermometers**

RTD/PT100 2 wire (optional 3 wire)  
 DIN 43760 100 Ω 0°C/138.5 Ω 100°C Pt

**Linear process inputs:** 0-20mV/4-20mV  
 Linearity: ±1.5% Impedance 100k Ω min

**Applicable to all Inputs**

SR=sensor range, CR=configured range  
 Calibration accuracy: ±0.25% SR ±1°C  
 Sampling frequency: Input 3Hz, CJC 5sec  
 Common mode rejection: Negligible effect up to 140dB, 240V, 50-60Hz  
 Series mode rejection: 60dB, 50-60Hz  
 Temperature coefficient: 150ppm/°C SR  
 Reference conditions: 22°C ±2°C, 115/230V ±5%, after 30m settling time

**OUTPUTS**

**OUTPUT MODULE - Dual standard**

**Main output: SP1**  
 Relay standard: 5A/250Vac resistive SPDT/Form C  
 SSd-optional: 5V/25mA non-isolated

**Alarm/Cool channel output: SP2**

Relay-standard: 3A/250Vac resistive SPDT/Form C  
 SSd-optional: 5V/25mA non-isolated

**9900 Controller output module - types**

	SP1 output	SP2	115V code	230V
Relay	Relay	991.11C/F	991.12C/F	
Relay	SSd	991.21C/F	991.22C/F	
SSd	Relay	992.11C/F	992.12C/F	
SSd	SSd	992.21C/F	992.22C/F	
Relay	-	991.01C/F	991.02C/F	
SSd	-	992.01C/F	992.02C/F	

1. CONFIGURATION  
 All functions are front key selectable, it is the responsibility of the installing engineer to ensure that the configuration is safe. Remove the function lock link to protect critical functions from tampering.
2. ULTIMATE SAFETY ALARMS  
 Normal safety advice: Do not use SP2 as the sole alarm where personal injury or damage may be caused by equipment failure.

10.2 MECHANICAL

1. Prepare a 1/16 DIN panel cut out: 45 x 45mm +0.6 -0 1.77" x 1.77" +0.02 -0
2. Remove the socket, pressing in the lock buttons
3. Slide the controller into the cut out
4. Fit the mounting clip see fig. pressing it firmly against the panel, jacking screws optional
5. Plug on the socket
6. After installation remove and discard the protective front window label
7. Cleaning - if required wipe with damp cloth (water only)

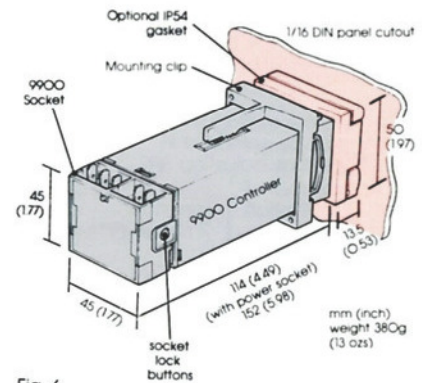

Fig. 6

**CONTROL CHARACTERISTICS**

<b>SPI PID Parameters</b>	<b>Field selectable</b>
Prop band/Gain	0.5-100% CR
Prop cycle-time	0.05-81s or ON/OFF
Integral time/Reset	0.2-43m or OUT
Derivative time/Rate	1.0-255s or OUT
DAC approach control (ON/OFF Hysteresis)	0.5-9.0 x PB 0.25-50%CR

**GENERAL**

Supply Voltage: 115V or 230V ±15% 50-60Hz 6VA (Link selectable)  
 Digital LED Display: 3½ digit 10mm high. High brightness green. 3 step LED.  
 Error indicator: SP1 Green SP2 Amber.  
 Output LEDs: 4 Elastomeric Buttons.  
 Keypad:

**ENVIRONMENTAL**

Humidity: Max. 80%  
 Altitude: Up to 2000M  
 Installation: Categories II and III  
 Pollution: Degree II  
 Safety: UL873, CSA 22.2/142-87, EN61010  
 Protection: IP54 (with gasket)  
 EMC Emission: EN50081-1  
 FCC Rules 15 Sub-part J Class A  
 EMC Immunity: EN50082-1, RF Field ±2% FS  
 Ambient: 0.50°C (32-130°F)  
 Mouldings: Flame Retardant Polycarbonate



CAL Controls policy of continuous development may cause detail changes to the enclosed information. E & OE

11 ERROR MESSAGES

APPLICATION FAULTS

<b>EE1</b> Sensor burnout	Check sensor	Self clearing
<b>EE2</b> RTD/PT100 short	Check sensor	Self clearing
<b>EE3</b> LBA Loop break	Check control loop	Latches: Reset

AUTOTUNE AT/PT TUNING CYCLE FAULTS

Autotune run is aborted: Previous values are retained  
**EE5** Outside time limit Latches: Reset  
**EE6** O/shoot exceeds limit Latches: Reset  
**EE7** Unable to run Autotune, SPI in ON/OFF mode Latches: Reset

SOFTWARE FAULTS

<b>EE8</b> Calibration data error	Replace unit if it persists
<b>EE9</b> System error	Replace unit

PRESS ▼▲ together to reset latched message

**WARRANTY**

**CAL Controls warrant this product free of defects in workmanship and materials for three (3) years from date of purchase**

1. Should the unit malfunction, return it to the factory. If defective it will be repaired or replaced at no charge
2. There are no user-serviceable parts in this unit. This warranty is void if the unit shows evidence of being tampered with or subjected to excessive heat, moisture, corrosion or other misuse
3. Components which wear, or damage with misuse, are excluded e.g. Relays, SSR
4. To comply with this warranty the installation and use must be by suitably qualified personnel
5. Neither CAL Controls Ltd or CAL Controls Inc shall be responsible for any damage or loss to other equipment howsoever caused, which may be experienced as a result of the installation or use of this product. CAL Controls liability for any breach of this agreement shall not exceed the purchase price paid



### 13 IMPORTANT: ADVANCED FUNCTIONS SECURITY

The advanced functions are intended for OEM's and process engineers. Access is therefore protected in the Function table

**To avoid unauthorised use of these functions remove this section from the manual before supply to end user**

#### 13.1 'HIDDEN' ACCESS TO ADVANCED FUNCTIONS

Step 1

PRESS **P** TO ENTER PROGRAM MODE

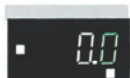

Step 2

PRESS **▼** TO GO DIRECTLY TO FUNCTION 13



Step 3

PRESS & HOLD **★** FOR 5 sec TO ACCESS ADVANCED FUNCTIONS (Entry point Fn 38)



#### 13.2 ADVANCED FUNCTIONS ... Protected

Fn Opt Parameter  
No. No.

##### 26 SP1 Heat Power limit

0	100% max	8	60%
1	95% output	9	55%
2	90%	10	50%
3	85%	11	45%
4	80%	12	40%
5	75%	13	30%
6	70%	14	20%
7	65%	15	10%

Not in SP1 ON/OFF mode

##### 27 SP2 Cool limit

0	100% max	4	40%
1	80% output	5	30%
2	60%	6	20%
3	50%	7	10%

Not in SP2 ON/OFF mode

##### Direct/Reverse mode selection

	Normal	OFF when logically ON
28 SP1 Output	0	1
29 SP1 LED	0	1
30 SP2 Output	0	1
31 SP2 LED	0	1

##### 32 Error indicator resolution

0	Normal (2% range/segment)
1	High (1%)
2	Low (4%)

##### 33 Temperature display sensitivity

0	Normal
1	High
2	Low

##### 34 Derivative polling ratio

0	0.5 x derivative time
1	0.2
2	0.7
3	1.0

##### 35 Sensor span adjust

1% steps (+15° / -16° max)

Note 'Hidden' Fn 15/Opt 5 resets ALL functions, except Fn 22

### 36 SP2 Latch alarms

0 Normal  
1 Latch

Only for: SP2 ON/OFF mode, Fn 19/Opt 1-5

PRESS **▼▲** together to reset (in non alarm condition)

### 37 Spare

#### DIAGNOSTICS

Read only Functions 39-49 Mode B display see 4.2

#### PERFORMANCE MONITOR (PM)

### 38 Start monitor (Entry point from Fn 13)

0 OFF  
1 Start

Readings are reset on subsequent monitor start or de-powering

### 39 Read temperature variance (0.1°)

### 40 Read maximum temperature (°C/°F)

### 41 Read minimum temperature (°C/°F)

### 42 Read Duty Cycle Monitor (DCM) % heat (SP1 % ON time)

#### AUTOTUNE TUNING DATA Fig. 8

Overshoot/Undershoot (°C/°F)  
Max 255° /Hi-res 25.5°

43 OS1 45 US  
44 OS2

Quarter cycle times (sec)  
Min 2 sec/max 1800 sec (30 min)

46 QCT1 48 QCT3  
47 QCT2 49 QCT4

50 Spare PRESS **▲** to Fn 0

#### 13.3 DIAGNOSTICS Functions 38 - 49

To assist with machine development, commissioning and trouble shooting

#### PERFORMANCE MONITOR (PM)

Monitors and displays minimum and maximum temperatures, and variance (deviation) to 0.1°C/°F. Displayed temperatures are measured values, independent of set point. This high sensitivity monitor may be affected by interference. (Fit snubber to minimise disturbance)

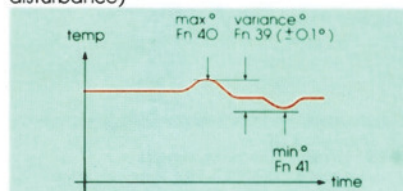

Fig. 7 Performance monitor (PM) Fns 38-41

#### DUTY CYCLE MONITOR (DCM)

Monitors percentage power used in the previous proportioning cycle. Average several readings for a more accurate result. Power requirements outside the range 20% - 80% may be difficult to control and autotune

#### AUTOTUNE TUNING DATA (Fns 43-49)

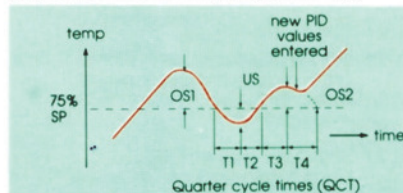

Fig. 8

### 13.4 MONITOR OPERATION (PM/DCM)

Step	Select
1 To start monitor:	Fri 38/Opt 1
2 To return to normal operation	PRESS <b>P</b>
3 To view readings (PM/DCM)	Fns 39-42
4 To stop monitor: (Readings are retained)	Fri 38/Opt 0
5 Reset	Fri 38/Opt 1
Readings reset on next monitor start.	On de-powering
Monitor and readings reset	On de-powering

### 14 PROGRAM SECURITY LOCK

To be made by qualified technician. De-power controller before proceeding using a screw driver at side of bezel remove lower fascia containing push buttons. All functions except user settings - Functions 1-3 can be protected against tampering. To protect function settings change the plastic link from unlocked to locked position.

- LOCKED (or remove link)
- UNLOCKED

### 15 INTERNAL LINK CHANGES

These operational modifications should be made by a qualified technician before installation.

To remove the 9900A board:  
1. First remove the output module, carefully lever the retaining clips from the slots in the module cover with a small screwdriver.



2. Tap module cover on table top, as shown, to release the 9900A board. Carefully remove board, avoid damaging components on protruding tongue

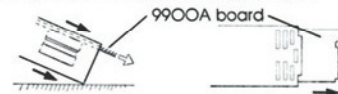

15.1 To convert to 3 wire RTD/PT100 (inhibits thermocouple operation) Carefully cut pad at X avoid damage to R3. Fit solder links LK1, LK2 using 22SWG wire.

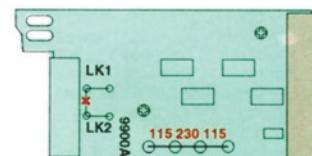

15.2 Supply Voltage Conversion (Plug in links) IMPORTANT - check your installation operating voltage before proceeding. Wrongful conversion could damage this unit.

For 115 Volt ±15% operation fit two links (spare link in accessories bag) in positions 115 and 115. For 230 Volt ±15% operation fit one link in position 230.

9900 FUNCTION/OPTION RECORD			
Customer Ref:			
9900		model	serial no.
Function Number	date:	Option Set	



## 17 COOL STRATEGY FOR HEAT-COOL APPLICATIONS

**Cool strategy:** A change in load causes movement of the linked heat and cool prop bands

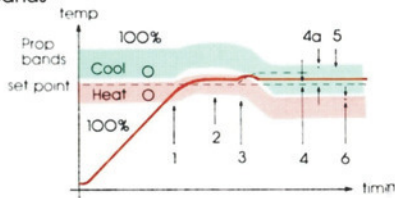

Fig. 9

1. Integral causes linked prop bands to move up
2. Stabilises e.g. 30% heat
3. Exothermic load change causes integral to move prop bands down minimising disturbance
4. Minimum offset achieved (4a = offset without cool strategy integral action)
5. Stabilises e.g. 50% cool
6. Consistent dead band throughout

## 17.1 SETTING UP ROUTINE FOR HEAT COOL (Single zone procedure)

### Step

1. **Run Autotune AT:** (Set normal operating temp) Accept AT proportional cycle time **Fn 4/Opt 15**  
Note SPI/SP2 cycle times must be compatible with switching devices used (SP2 cool output is OFF at this stage)
2. **When temperature stable at set point:**
  - Select **cool strategy** **Fn 19/Opt 7**
  - Select **cool prop band** option value from table nearest to Heat prop band value (view Fn 5) **Fn 11**
  - Select **cool cycle time** option value nearest to Heat cycle time value (view Fn 4) **Fn 10**
  - Adjust SP2 dead band to 0° (Factory set 5°) **Fn 2**
3. **Run with normal background/exothermic thermal conditions,** good results should be achieved and provide the basis for fine tuning
4. **Further adjustments:** e.g. Water cooling. Should oscillation occur try (in order):
  - Double **cool prop band** value **Fn 11** and reduce integral time value **Fn 8**
  - Halve **cool cycle time** **Fn 10**
  - Introduce **cool overlap** **Fn 2/(-)ve**
5. **Non-linear cooling**  
For water cooling above 100°C where flash to steam occurs. Select non-linear ranges in **cool cycle time** **Fn 10/Opt 13-15**
6. **Fine tuning**  
If **overshoot** (into cool) or **undershoot** (into heat) occurs, slowly make the following adjustments, observing the results:
  - Increase **cool overlap** **Fn 2/(-)ve**
  - Apply SP2 **cool limit**, progressively **Fn 27/Opt 1**
  - If needed: SP1 heat limit **Fn 26/Opt 1**
7. **Contact CAL for more application advice and data if required**

## 19 RECALIBRATING TO A REMOTE STANDARD

To enable the 9900 calibration to match an external meter, data logger etc. (i.e. 'Remote' reading)

### SENSOR ERROR CORRECTION: Fn 9

Provides correction at one single temperature

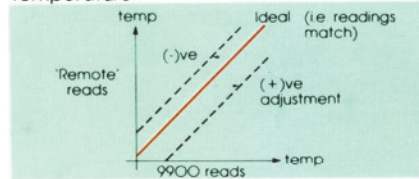

**Example**  
9900 Reads 404°  
'Remote' 400°

Error +4° Set (-4) correction at Fn 9  
Note Error polarity applies to 9900 correction

### Sensor span adjust: Fn 35

Provides correction where two temperatures require differing amounts of adjustment

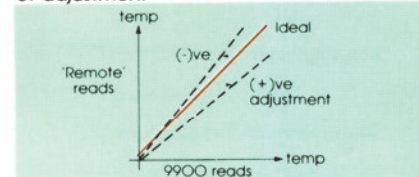

1. Choose a temperature towards the bottom of the normal operating range and one at the top
2. Run at the lower temperature T1, note the error E1 between 9900 and 'Remote' reading
3. Repeat at upper temperature T2 and note error E2

**Example**  
9900 T1 reads 60° T2 reads 200°  
'Remote' 58° 205°  
Error E1 = +2° E2 = -5°

### 4. Calculation of span adjustment for Fn 35

Formula:  $Fn\ 35 = \frac{E2 - E1}{T2 - T1} \times CR$  (as Fn 24)

$$\text{Example: } Fn\ 35 = \frac{(-5^\circ) - (+2^\circ)}{200^\circ - 60^\circ} \times 250^\circ$$

$$= \frac{-3}{140} \times 250$$

$$Fn\ 35 = -5^\circ \text{ Set } (-5^\circ) \text{ in Fn 35}$$

5. A span error entered in Fn 35 immediately changes the reading, allow time to stabilise at T2, if an error exists correct with Fn 9. Then check at T1, if an error exists check readings and calculations; repeat if necessary

## 20 PID TUNING NOTES

1. **Proportional cycle time: Fns 4/10**  
Determines the cycle rate of the output device

### Output device

9900 Internal relays  
SSR  
Linear output (mA/Vdc)

### Recommended time

10 sec minimum (5 sec with derated contacts & snubber)  
1 sec  
0.05 sec

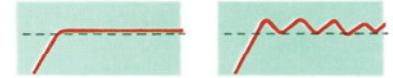

Ideal

Too long (oscillates)

2. **Proportional band/Gain: Fn 5/11**  
Smooths out oscillation occurring in ON/OFF control

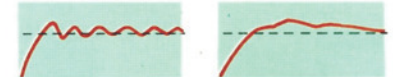

Too narrow (oscillates)

Too wide (slow warm up and response)

3. **Integral time/Reset: Fn 8**  
Automatically corrects offset errors caused by proportional control

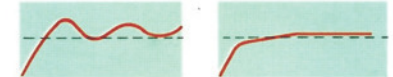

Too short (overshoots and oscillates)

Too long (slow warm up and response)

4. **Derivative time/Rate: Fn 6**  
Suppresses overshoot and speeds response to disturbances

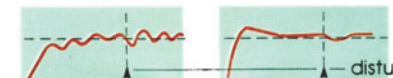

Too long (oscillates and over corrects)

Too short (slow warm up and response under corrects)

5. **DAC approach control: Fn 7**  
Tunes warm up characteristics independent of normal operating conditions. Controls when derivative action starts on warm up, (smaller setting = closer to set point) Useful when sensor very remote from heater

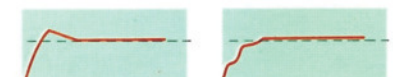

Too small (overshoot)

Too large (slow stepped warm up)

## 21 PID MANUAL TUNING GUIDE

For unusual applications producing error messages (EE5/6) on Autotune AT/PT

1. **Initial settings:**

Fn 5/Opt 0 (or Reset funtions: Fn 15/Opt 1)  
Fn 4/Opt 7 (ON/OFF Mode)  
Normal operating set point (Then allow process to stabilise)

2. **Take several readings of:**

Amplitude A

Time period T

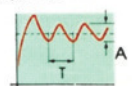

(Diagnostics Fns 38/39 may help)

3. **Set PID values:**

**Fn 4** Prop cycle time (Ensure compatible with output device)  $\frac{T}{20}$  sec Nearest

**Fn 5** Prop band/Gain  $A \times 1.5 \times 100\%$  config range Next larger

**Fn 6** Derivative time/Rate  $\frac{T}{10}$  sec Next shorter

**Fn 8** Integral time/Reset  $\frac{T}{60}$  min Next longer

**Fn 7** DAC Approach control 1.5 factory set **see 20.5**

## 18 NOTES ON OTHER FUNCTIONS

### Function Item

#### Fn 0 Park mode (Opt 3)

Temporarily turns outputs off

Display: and Process temperature

Useful in commissioning and trouble shooting, e.g. Multizone applications  
**Manual heat %** (Opt 4-100)  
If sensor break occurs (EE1/2) SP1 output (heater power) may be manually controlled 4-100% (Not in ON/OFF mode)

Display: XXH (XX = % output)

#### Fn 3 SP1 Set point lock

Stops unauthorised adjustment

#### Fn 5 Retransmission:

With 100% prop band, accuracy ±5% configuration range using linear input/output

#### Fn 16 Linear process inputs

Optional 9900-PIM Process interface module (Data from CAL)  
This remote module provides greater versatility when using the 9900 with linear inputs

#### Fn 17 Negative temperature ranging

Enables type T/RTD-PT100 to be used below 0°C/32°F  
Note Increased range to -200°C/F, may effect PID values

#### Fn 18 Display resolution

Note Effect on set point and other values set in °C/°F e.g. 100.0° in hi-res = 1000° in normal

#### Fn 26 SP1 Heat power limit

Limits maximum heater power during warm up. Useful if heaters oversized

#### Fn 27 SP2 Cool power limit

Limits maximum cooling power outside prop band in heat-cool

STANDARD INPUT

CAL9910xx Single 5A Relay  
 CAL9920xx Single 5VDC SSR

3-WIRE PT100 INPUT

CAL9810xx Single 5A Relay  
 CAL9820xx Single 5VDC SSR

The single output models listed above have only one output fitted which has different connections to the two output versions described in this manual.

Please read carefully the following information to ensure correct use of the controller.

SINGLE OUTPUT MODEL WIRING

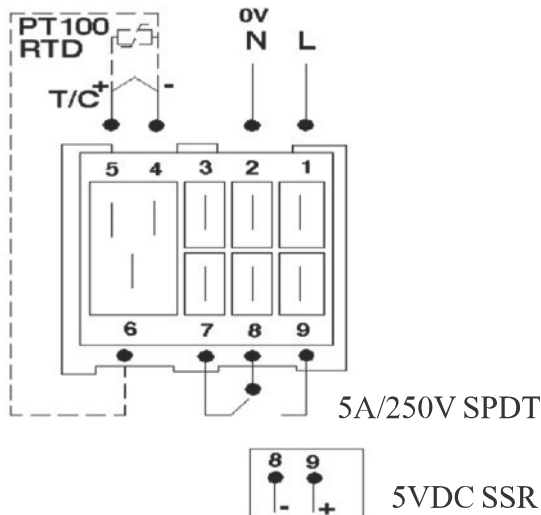

TYPICAL WIRING DIAGRAM FOR SINGLE OUTPUT

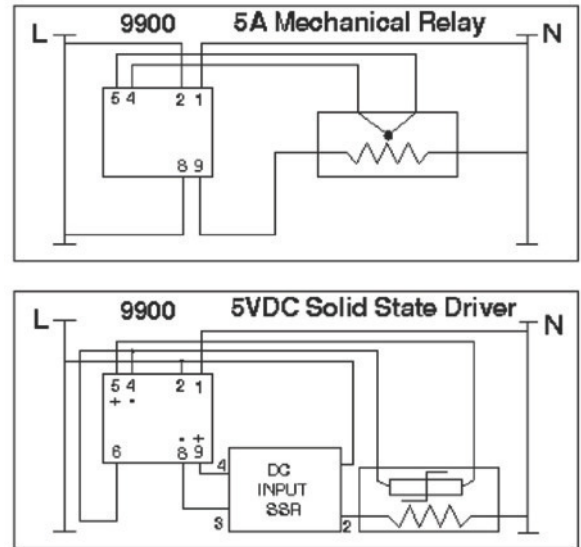

WEST Control Solutions — your global partner for temperature and process control

International Sales and Support



Austria

PMA Prozeß- und Maschinen-Automation GmbH  
 Liebermannstraße F01  
 2345 Brunn am Gebirge  
 Tel.: +43 (0)2236 691-121  
 Fax: +43 (0)2236 691-102  
 Email: info@west-cs.com



China

Danaher Setra-ICG  
 Tianjin Co. Ltd. No. 28 Wei 5 Road  
 The Micro-Electronic Industry Park TEDA  
 Xiqing District • Tianjin 300385  
 Tel.: +86 22 8398 8098 • Sales: +86 400 666 1802  
 Fax: +86 22 8398 8099  
 Email: tc.sales@danaher.com



France

WEST Control Solutions  
 France  
 Tel.: +33 (0) 1 77 80 90 41  
 Fax: +33 (0) 1 77 80 90 47  
 Email: info@west-cs.com



Germany

PMA Prozeß- und Maschinen-Automation GmbH  
 Miramstraße 87  
 34123 Kassel  
 Tel.: +49 (0)561 505-1307  
 Fax: +49 (0)561 505-1710  
 Email: info@west-cs.com



United Kingdom

WEST Control Solutions  
 The Hyde Business Park  
 Brighton • East Sussex • BN2 4JU  
 Tel.: +44 (0)1273 606271  
 Fax: +44 (0)1273 609990  
 Email: info@west-cs.com



United States

WEST Control Solutions  
 1675 Delany Road  
 Gurnee • IL 60031-1282  
 Tel.: 800 866 6659  
 Fax: 847 782 5223  
 Email: custserv.west@dancon.com

